



FADINI
el abre verjas



Puertas & Portones Automáticos, S.A. de C.V.
¡Nuestra pasión es la Solución!....

» OPERADOR HIDRAULICO ABATIBLE MOD.COMBI-740.

Combi 740

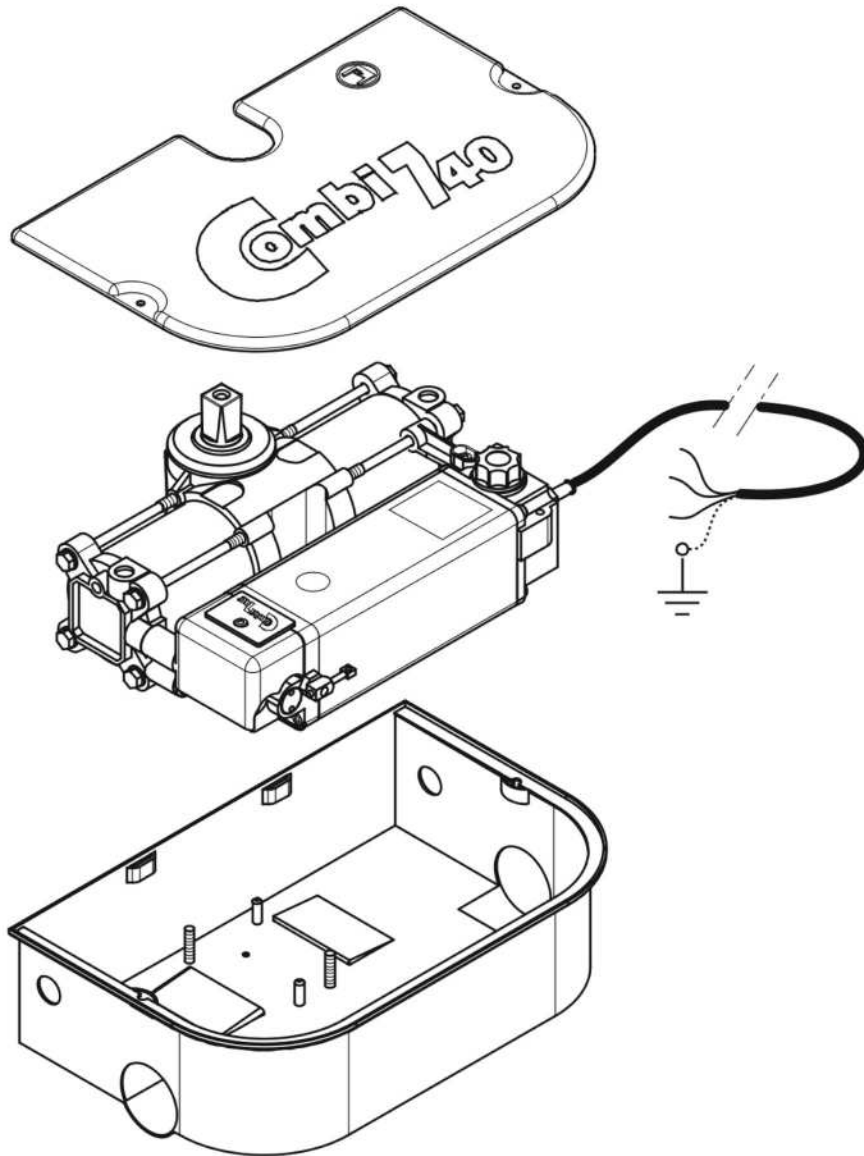

(229) 288-1552

portonesautomaticos@adsver.com.mx
portonesautomaticos@prodigy.net.mx



RESIDENCIAL



COMERCIAL



INDUSTRIAL

MEMBER



International Door Association









V07.20

(229) 927-5107, 167-8080, 167-8007, 151-7529.

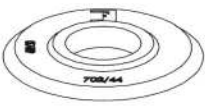
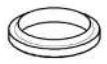

www.adsver.com.mx



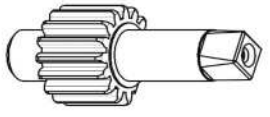

» OPERADOR HIDRAULICO ABATIBLE MOD.COMBI-740.

FADINI® l'apricancello		COMBI 740		SP.K17 PEZZI DI RICAMBIO	
RIF. ARTICOLO	FIGURA	POSIZIONE	DENOMINAZIONE	QUANTITA'	CODICE D'ORDINE
74001		1	Coperchietto di protezione <i>(sostituito con codice d'ordine 740172)</i>	1	740172
74002		2	Guarnizione tenuta polvere WRM118149	1	740157
74003		3	Flangia di tenuta su albero centrale	1	740185
74004		4	Guarnizione OR 4118	1	740157
74005		5	Guarnizione OR 159	1	740157
74006		6	Ghiera con foro quadro	1	74006
74007		7	Seeger J63	1	740185
		8			
74009		9	Cuscinetto radiale 6206	2	740186
74010		10	Albero centrale dentato	1	740186

Le immagini riportate in questo listino sono puramente indicative.



» OPERADOR HIDRAULICO ABATIBLE MOD.COMBI-740.

 FADINI l'apricancello		COMBI 740		SP.K17 PEZZI DI RICAMBIO	
74011		11	Reggispinta 51106	1	740186
74012		12	Dado speciale lungo 100	2	74012
74013		13	Martelletto dentato destro	1	740110
74014		14	Fermo dentato destro	1	740110
74015		15	Molla a compressione 0,8x7x32	2	740110
74016		16	Vite M5x16 TEI	4	740110
74017		17	Guarnizione OR 3043	4	740157
74018		18	Corpo valvola destro	1	740110
74019		19	Sfera ø 7,2	2	740110
74020		20	Seeger J14 <i>(non si usa più)</i>	2	
74021		21	Vite di sfiato <i>(non si usa più)</i>	2	740188

Le immagini riportate in questo listino sono puramente indicative.



» OPERADOR HIDRAULICO ABATIBLE MOD.COMBI-740.













 FADINI l'apricancello		COMBI 740		SP.K17	
				PEZZI DI RICAMBIO	
74022		22	Guarnizione OR 108	4	740157
74023		23	Registro di portata	2	740188
74024		24	Testata destra	1	740188
74025		25	Stantuffo	2	740184
74026		26	Disco in acciaio	2	740184
74027		27	Camicia	2	74027
74028		28	Asta dentata da 110°	1	74028
74029		29	Martelletto dentato sinistro	1	740111
74030		30	Fermo dentato sinistro	1	740111
74031		31	Corpo valvola sinistro	1	740111
74032		32	Testata sinistra	1	740189

Le immagini riportate in questo listino sono puramente indicative.



V07.20











» OPERADOR HIDRAULICO ABATIBLE MOD.COMBI-740.

 FADINI l'apricancello		COMBI 740		SP.K17	
				PEZZI DI RICAMBIO	
74033		33	Vite M8x125 TE di fissaggio testata martinetto 110°	8	74033
74034		34	Guarnizione OR 171	2	740157
74035		35	Ferma guarnizione modello 700/8	2	740184
74036		36	Guarnizione stantuffo RSS 60 75	2	740157
74037		37	Guarnizione OR 4300	2	740157
74038		38	Ogiva da 8	2	740112
74039		39	Raccordo blocca ogiva	1	740112
74040		40	Monoblocco a croce	1	74040
74041		41	Tubetto in rame di mandata per 110°	1	740112
74042		42	Dado blocca ogiva	1	740188
74043		43	Raccordo da 1/4" ad angolo	1	740188

Le immagini riportate in questo listino sono puramente indicative.

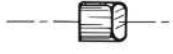







» OPERADOR HIDRAULICO ABATIBLE MOD.COMBI-740.

FADINI® l'apricancello		COMBI 740		SP.K17 PEZZI DI RICAMBIO	
74044		44	Vite M6x20 TEI inox	9	74044
74045		45	Attacco centralina/martinetto	1	74045
74046		46	Tappo serbatoio	1	740187
74047		47	Guarnizione OR 3112	1	740157
74048		48	Targa adesiva dati tecnici	1	74048
74049		49	Bollino di riconoscimento <i>(non si usa più)</i>	1	
74050		50	Tirante M5x155 motore/pompa	2	74050
74051		51	Parastrappi in ottone <i>(non si usa più)</i>	1	
74052		52	Vite M5x30 TEI <i>(non si usa più)</i>	3	
74053		53	Guarnizione OR 3056	3	740157
74054		54	Crocevia olio martinetto/centralina idraulica	1	740112

Le immagini riportate in questo listino sono puramente indicative.















» OPERADOR HIDRAULICO ABATIBLE MOD.COMBI-740.

		COMBI 740		SP.K17	
				PEZZI DI RICAMBIO	
74055		55	Tappo laterale blocco bidirezionale	2	740151
74056		56	Guarnizione OR 119	2	740157
74057		57	Molla conica 0,35x7,2x12	2	740151
74058		58	Cilindro a tappo senza blocco	1	74058
74059		59	Sede valvola di ritenuta	2	740151
74060		60	Sfera ø 6,35 inox per sede valvola	2	740151
74061		61	Cilindretto bidirezionale	1	740151
74062		62	Pastiglia in nylon valvola di massima	2	740157
74063		63	Molla a compressione 1,5x7,5x28	2	740151
		64			
74065		65	Guarnizione OR 2043	5	740157

Le immagini riportate in questo listino sono puramente indicative.











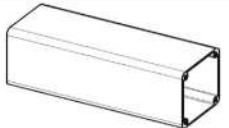

» OPERADOR HIDRAULICO ABATIBLE MOD.COMBI-740.

 FADINI l'apricancello		COMBI 740		SP.K17 PEZZI DI RICAMBIO	
74066		66	Registro filettato	2	740151
74067		67	Coperchio copri valvola di massima pressione	1	74067
74068		68	Vite M6x16 TEI	1	74068
74069		69	Raccordo di giunzione uso bullone	1	74069
74070		70	Guarnizione OR 109	1	740157
74071		71	Grano M6x8	1	740151
74072		72	Leva di registro sblocco	1	740151
74073		73	Ghiera di fermo registro	1	740151
74074		74	Perno blocco/sblocco con pastiglia	1	740151
74075		75	Guarnizione OR 2031	1	740157
74076		76	Corpo valvola bidirezionale	1	740151

Le immagini riportate in questo listino sono puramente indicative.



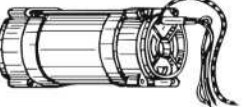







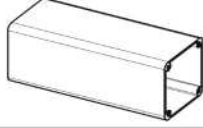

» OPERADOR HIDRAULICO ABATIBLE MOD.COMBI-740.

 FADINI l'apricancello		COMBI 740		SP.K17 PEZZI DI RICAMBIO	
74077		77	Guarnizione di tenuta	2	740157
74078		78	Grano M6x6 tappo-fori <i>(non si usa più)</i>	3	
74079		79	Serbatoio olio l = 235 mm per martinetto 175°	1	74079
74080		80	Guarnizione OR 106 <i>(non si usa più)</i>	2	
74081		81	Fermo a "G" <i>(sostituito con codice d'ordine 740125)</i>	2	740125
74082		82	Sfere di aspirazione ø 6,35	2	740151
74083		83	Pompa idraulica a-lobi <i>(non si usa più)</i>	1	
74084		84	Filtro aspirazione olio <i>(non si usa più)</i>	1	
74085		85	Motore elettrico 0,25 CV <i>(non si usa più)</i>	1	
74086		86	Morsetto attacco cavi	4	74086
74087		87	Tirante M5x142 motore/pompa <i>(non si usa più)</i>	1	8

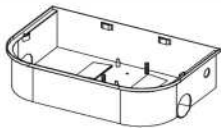
Le immagini riportate in questo listino sono puramente indicative.





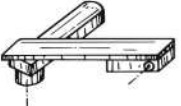



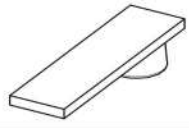

» OPERADOR HIDRAULICO ABATIBLE MOD.COMBI-740.

 FADINI l'apricancello		COMBI 740		SP.K17	
				PEZZI DI RICAMBIO	
74088		88	Serbatoio olio l = 205 mm per martinetto 110°	1	74088
74089		89	Fondello con sede cavo elettrico	1	740187
74090		90	Cavo elettrico completo da 2,50 m	1	74090
74091		91	Inserto autofilettante	2	74091
74092		92	Cassaforma alloggio martinetto/centralina	1	74092
74093		93	Vite M5x10 TCC massa a terra	1	74093
74094		94	Capocorda da 5 mm per massa a terra	1	74094
74095		95	Coperchio di protezione in alluminio	1	74095
74096		96	Copri base in acciaio inox <i>(non si usa più)</i>	1	
74097		97	Vite M5,5x19 TE inox	2	74097
74098		98	Sblocco di emergenza meccanico <i>(sostituito con codice d'ordine 740164 o 740165)</i>	1	9

Le immagini riportate in questo listino sono puramente indicative.



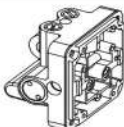

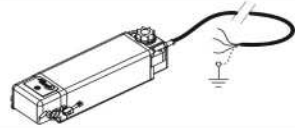
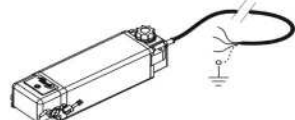







» OPERADOR HIDRAULICO ABATIBLE MOD.COMBI-740.

 FADINI l'apricancello		COMBI 740		SP.K17 PEZZI DI RICAMBIO	
74099		99	Dispositivo di fissaggio senza blocco idraulico	1	74099
740100		100	Chiave blocco/sblocco	1	740100
740101		101	Cardine distanziatore con rondella	1	740101
740102		102	Prigionieri di fissaggio	2	740102
740103		103	Olio idraulico "Oil Fadini", fornito in taniche da 2 litri	1	740103
740104		104	Collare di rinforzo staffa di sblocco per cassaforma autoportante	1	740104
740105		105	Corpo valvola bidirezionale completa di art: 17-44-55-56-57-59-60-61-62-63-65-66-76-77-82	1	740105
740106		106	Rondella ø 8	8	740106
740107		107	Raccordo a "T" con ogiva da 8 e dado blocca ogiva	1	740107
740108		108	Solo centralina idraulica con serbatoio, motore elettrico, pompa idraulica e valvola con blocco	1	740108
740109		109	Solo centralina idraulica con serbatoio, motore elettrico, pompa idraulica e valvola senza blocco	1	740109

Le immagini riportate in questo listino sono puramente indicative.

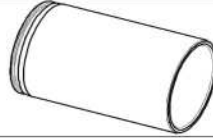
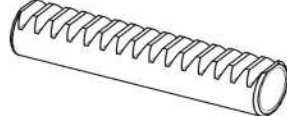
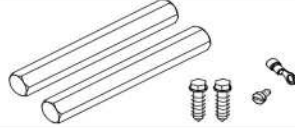

» OPERADOR HIDRAULICO ABATIBLE MOD.COMBI-740.

 FADINI l'apricancello		COMBI 740		SP.K17 PEZZI DI RICAMBIO	
740123		123	Regolatore di flusso	2	740123
740124		124	Raccordo di giunzione uso bullone per regolatore di flusso	1	740124
740125		125	Molla a compressione 0,5x6,5x6 <i>(non si usa più)</i>	2	740125
740126		126	Guarnizione OR 109 per raccordo di giunzione regolatore di flusso	1	740126
740127		127	Guarnizione OR 106	2	740127
740128		128	Camicia levigata per <u>175°</u>	2	740128
740129		129	Asta dentata da <u>175°</u>	1	740129
740130		130	Confezione completa di viti, prigionieri di fissaggio e capocorda	1	740130
740131		131	Raccordo di giunzione tubi dia.8	1	740131
740132		132	Tubetto in rame di mandata per 175°		740132
740133		133	Vite M8x150 TE di fissaggio testata martinetto 175°		740133

Le immagini riportate in questo listino sono puramente indicative.

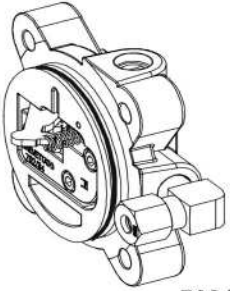
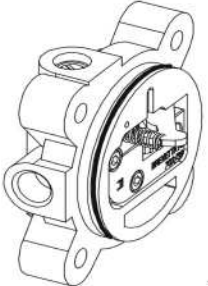
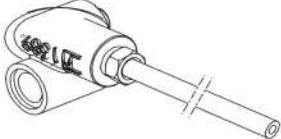
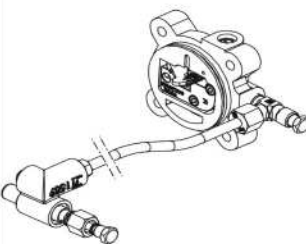

» OPERADOR HIDRAULICO ABATIBLE MOD.COMBI-740.

FADINI® l'apricancello		COMBI 740		SP.K17 PARTI COMPLETE
RIF. ARTICOLO	FIGURA	POSIZIONE	DENOMINAZIONE	CODICE D'ORDINE
740110	 702/18	110	Testata martinetto destra <u>autofrenante</u> completa di art: 13-14-15-16-17-18-19-22-23-24-34-38-42-43	740110
740111	 702/29	111	Testata martinetto sinistra <u>autofrenante</u> completa di art: 15-16-17-19-22-23-29-30-31-32-34	740111
740112		112	Crocevia olio completo di art: 38-39-41-53-54	740112
740113		113	Testata destra completa di art: 13-14-15-16-17-18-19-22-23-24-34-38-39-41-53-54-107-123-124-127 <i>(si consiglia di acquistare tutto il completo)</i>	740113

Le immagini riportate in questo listino sono puramente indicative.

12



V07.20

» OPERADOR HIDRAULICO ABATIBLE MOD.COMBI-740.

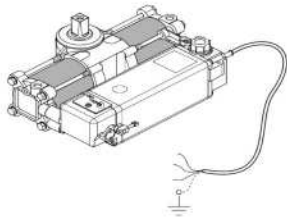
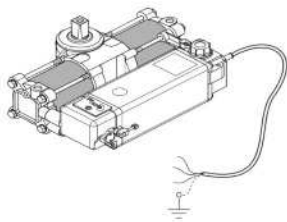
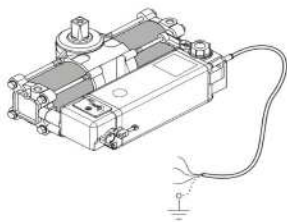
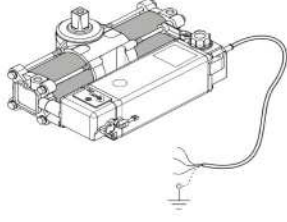
FADINI® l'apricancello		COMBI 740		SP.K17 PARTI COMPLETE
RIF. ARTICOLO	FIGURA	POSIZIONE	DENOMINAZIONE	CODICE D'ORDINE
740114		114	Centralina/martinetto Combi 740-110° senza blocco idraulico	740114
740115		115	Centralina/martinetto Combi 740-110° c/blocco idraulico	740115
740116		116	Centralina/martinetto Combi 740-175° senza blocco idraulico	740116
740117		117	Centralina/martinetto Combi 740-175° c/blocco idraulico	740117

Le immagini riportate in questo listino sono puramente indicative.

13



V07.20

» OPERADOR HIDRAULICO ABATIBLE MOD.COMBI-740.

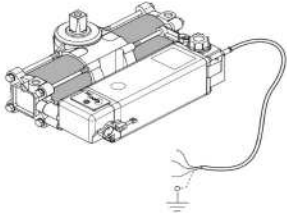
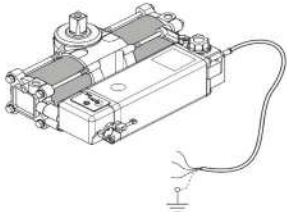
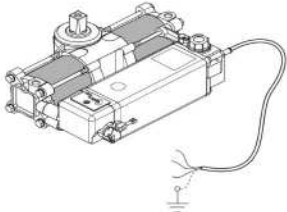
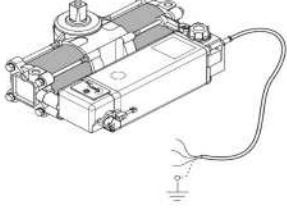
FADINI® l'apricancello		COMBI 740		SP.K17 PARTI COMPLETE
RIF. ARTICOLO	FIGURA	POSIZIONE	DENOMINAZIONE	CODICE D'ORDINE
740118		118	Centralina/martinetto Combi 740-110° <u>senza blocco</u> idraulico <u>autofrenante</u>	740118
740119		119	Centralina/martinetto Combi 740-110° <u>c/blocco</u> idraulico <u>autofrenante</u>	740119
740120		120	Centralina/martinetto Combi 740-175° <u>senza blocco</u> idraulico <u>autofrenante</u>	740120
740121		121	Centralina/martinetto Combi 740-175° <u>c/blocco</u> idraulico <u>autofrenante</u>	740121

Le immagini riportate in questo listino sono puramente indicative.

14













FADINI
el abre verjas



Puertas & Portones Automáticos, S.A. de C.V.
¡Nuestra pasión es la Solución!....

» OPERADOR HIDRAULICO ABATIBLE MOD.COMBI-740.

 FADINI l'apricancello		COMBI 740 - DX		SP.K17 PEZZI DI RICAMBIO	
740134		134	Raccordo lungo E17x138 mm G1/4" con OR 109	1	740134
740135		135	Valvola Combi 740 DX	1	740135
740136		136	Distanziale con OR 3056	1	740136
740137		137	Raccordo a tappo in ottone con OR 119	1	740137
740138		138	Tubetto di mandata ø 8 con raccordo angolare G1/4" e OR 2018	1	740138
740139		139	Tubetto ad innesto a due sezioni con raccordo angolare G1/4"	1	740139
740140		140	Tappo esagonale in ottone con OR 2031	1	740140
740141		141	Tubetto di mandata completo di raccordi ad angolo G1/4" ø 8 con tubetto di riduzione ad innesto con OR 2018 di tenuta		740141

Le immagini riportate in questo listino sono puramente indicative.

15

(229) 288-1552

 portonesautomaticos@adsver.com.mx
portonesautomaticos@prodigy.net.mx



RESIDENCIAL



COMERCIAL



INDUSTRIAL

MEMBER



International Door Association





V07.20

(229) 927-5107, 167-8080, 167-8007, 151-7529.

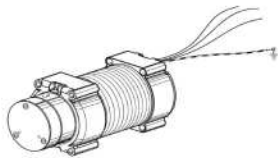
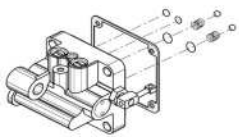

www.adsver.com.mx

» OPERADOR HIDRAULICO ABATIBLE MOD.COMBI-740.



FADINI® l'apricancello		COMBI 740		SP.K17 PARTI COMPLETE
RIF. ARTICOLO	FIGURA	POSIZIONE	DENOMINAZIONE	CODICE D'ORDINE
740150		150	Motore elettrico CV 0,25 con pompa P3, blocco unico con valvole di aspirazione nuova versione - dis. 4830 -	740150
740151		151	Corpo valvola bidirezionale completa di art: 17-22-44-55-56-57-59-60-61-62-63-65-66-71-72-73-74-75-76-77-82	740151
740152	 Dx	152	Completo sblocco manuale d'emergenza per Combi 740 con chiave di sblocco. <i>Versione Destra - Dx -</i> - cod. listino 748DXL -	740152
740153	 Sx	153	Completo sblocco manuale d'emergenza per Combi 740 con chiave di sblocco. <i>Versione Sinistra - Sx -</i> - cod. listino 748SXL -	740153

Le immagini riportate in questo listino sono puramente indicative.

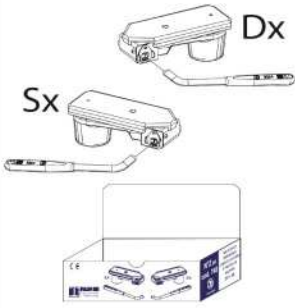
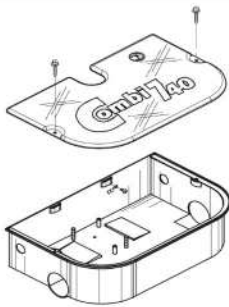
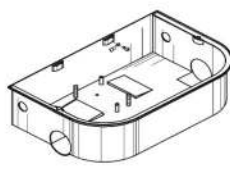

V07.20

» OPERADOR HIDRAULICO ABATIBLE MOD.COMBI-740.

FADINI® l'apricancello		COMBI 740		SP.K17 PARTI COMPLETE
RIF. ARTICOLO	FIGURA	POSIZIONE	DENOMINAZIONE	CODICE D'ORDINE
740154		154	Una scatola completa di 2 sblocchi manuali d'emergenza per Combi 740 e 2 chiavi di sblocco	740154
740155		155	Cassaforma di protezione completa di art: 91-92-95-97-130	740155
740156		156	Cassaforma di protezione completa di art: 91-92-130	740156
740157		157	Confezione serie guarnizioni, completa di art: 2-4-5-17-22-34-36-37-47-53-56-62-65-70-75-77-80	740157

Le immagini riportate in questo listino sono puramente indicative.

18



» OPERADOR HIDRAULICO ABATIBLE MOD.COMBI-740.





 FADINI l'apricancello		COMBI 740		SP.K17 PEZZI DI RICAMBIO	
740158		158	Piastra di copertura	1	740158
740159	 Dx	159	Piastra inferiore in acciaio Destra - Dx	1	740159
740160	 Sx	160	Piastra inferiore in acciaio Sinistra - Sx	1	740160
740161		161	Vite M8x18 TSEI inox di fissaggio piastra	1	740161
740162	 Dx	162	Braccetto di sblocco Destro - Dx	1	740162
740163	 Sx	163	Braccetto di sblocco Sinistro - Sx	1	740163
740164	 Dx	164	Sblocco di emergenza meccanico Destro - Dx	1	740164
740165	 Sx	165	Sblocco di emergenza meccanico Sinistro - Sx	1	740165
740166	 Dx	166	Staffa inferiore <i>per cassaforma autoportante</i> Destra - Dx	1	740166
740167	 Sx	167	Staffa inferiore <i>per cassaforma autoportante</i> Sinistra - Sx	1	740167
740168	 Dx	168	Sblocco di emergenza meccanico <i>per cassaforma autoportante</i> Destro - Dx	1	740168

Le immagini riportate in questo listino sono puramente indicative.

19

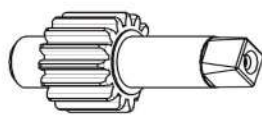

» OPERADOR HIDRAULICO ABATIBLE MOD.COMBI-740.

 FADINI l'apricancello		COMBI 740		SP.K17 PEZZI DI RICAMBIO	
740169	 Sx	169	Sblocco di emergenza meccanico <i>per cassaforma autoportante</i> Sinistro - Sx	1	740169
740170	 Dx	170	Piastra inferiore in acciaio Destra - Dx <i>COMPLETA</i>	1	740170
740171	 Sx	171	Piastra inferiore in acciaio Sinistra - Sx <i>COMPLETA</i>	1	740171
740172		172	Cuffia antiacqua in gomma	1	740172
740173		173	Albero centrale dentato con tacca di identificazione (<i>per Combi 787</i>)	1	740191
		174			
		175			
		176			
		177			
		178			
		179			

Le immagini riportate in questo listino sono puramente indicative.



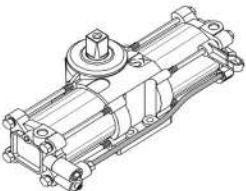
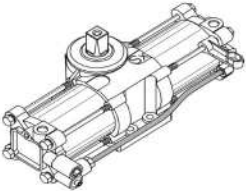
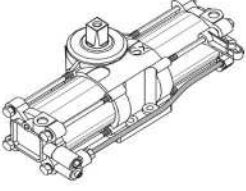
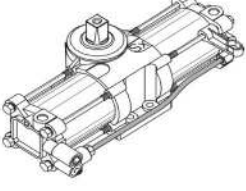

» OPERADOR HIDRAULICO ABATIBLE MOD.COMBI-740.

FADINI® l'apricancello		COMBI 740		SP.K17 PARTI COMPLETE
RIF. ARTICOLO	FIGURA	POSIZIONE	DENOMINAZIONE	CODICE D'ORDINE
740180		180	Solo martinetto <u>110°</u> <i>(Specificare Dx o Sx)</i>	740180
740181		181	Solo martinetto <u>110° - autofrenante</u> <i>(Specificare Dx o Sx)</i>	740181
740182		182	Solo martinetto <u>175°</u> <i>(Specificare Dx o Sx)</i>	740182
740183		183	Solo martinetto <u>175° - autofrenante</u> <i>(Specificare Dx o Sx)</i>	740183

Le immagini riportate in questo listino sono puramente indicative.

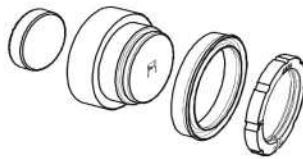

» OPERADOR HIDRAULICO ABATIBLE MOD.COMBI-740.

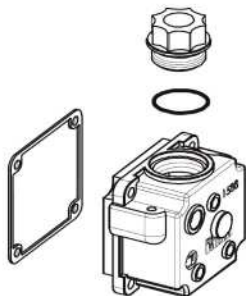
FADINI® l'apricancello		COMBI 740		SP.K17 PARTI COMPLETE
RIF. ARTICOLO	FIGURA	POSIZIONE	DENOMINAZIONE	CODICE D'ORDINE
740184		184	Stantuffo completo di art: 25-26-35-36	740184
740185		185	Flangia di tenuta completa di art: 2-3-4-5-7	740185
740186		186	Albero completo di art: 9-10-11	740186
740187		187	Fondello completo di art: 46-47-77-89	740187





Le immagini riportate in questo listino sono puramente indicative.

22



V07.20

» OPERADOR HIDRAULICO ABATIBLE MOD.COMBI-740.

FADINI® l'apricancello		COMBI 740		SP.K17 PARTI COMPLETE
RIF. ARTICOLO	FIGURA	POSIZIONE	DENOMINAZIONE	CODICE D'ORDINE
740188		188	Testata martinetto destra completa di art: 22-23-24-34-38-42-43	740188
740189		189	Testata martinetto sinistra completa di art: 22-23-32-34	740189
740190		190	Camicia con guarnizione OR 4300	740190
740191		191	Albero per <u>Combi 787</u> completo di art: 9-11-173	740191

23

Le immagini riportate in questo listino sono puramente indicative.





FADINI
el abre verjas



Puertas & Portones Automáticos, S.A. de C.V.
¡Nuestra pasión es la Solución!....

» OPERADOR HIDRAULICO ABATIBLE MOD.COMBI-740.



Puertas & Portones Automáticos, S.A. de C.V.
¡Nuestra pasión es la Solución!....

(229) 288-1552

portonesautomaticos@adsver.com.mx
portonesautomaticos@prodigy.net.mx



RESIDENCIAL



COMERCIAL



INDUSTRIAL

MEMBER



International Door Association



V07.20

(229) 927-5107, 167-8080, 167-8007, 151-7529.



www.adsver.com.mx